

1x1  
Infra Floor System

1x1FR  
Infra Floor System

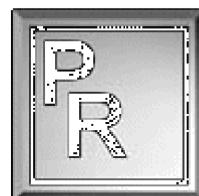
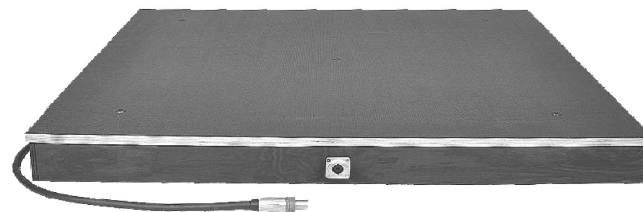
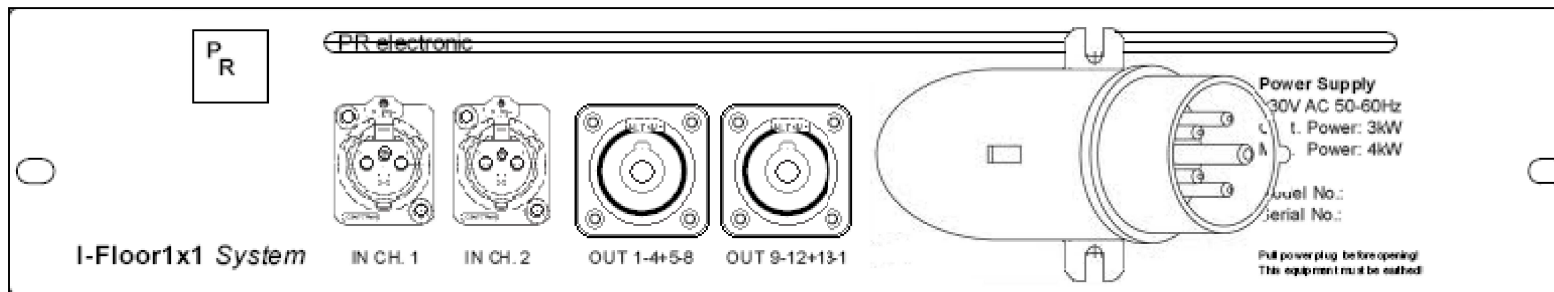
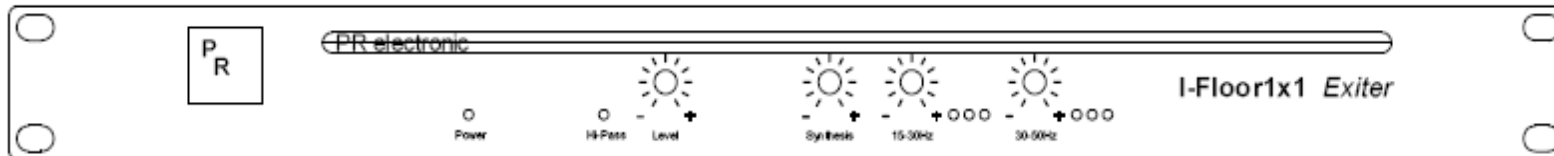

## Content

Introduction	1
Controls / Connections	2
Configuration 2 Systems	4
Installation	5
Adjustment Hints	7
Configuration with Audio-System	8
Pin Out Connectors	9
Technical Data	11
Service Address	12

## Introduction

Thank You for purchasing a PR Sound product from PR electronic, Germany. The systems of the **I-Floor**<sup>1x1</sup> und **I-Floor**<sup>1x1FR</sup> Series are products of the newest state of technology. Through the tough body, the most modern circuit technology and extensive protection measures a reliable and fail-safe operation is ensured in every surroundings.

The devices of the PR Sound I-Floor Series are high performance vibration floors, which make frequencies appreciable in the infrasound area. At the I-Floor<sup>FR</sup> Series they make also additionally frequencies in the audible audio area noticeable. The plates of the I-Floor<sup>®</sup> Series serve in the process exclusively for the transfer of very deep, nearly inaudible frequencies, the plates of the I-Floor<sup>FR</sup> Series supplementary own sound converters, which can emit sound waves in the audible area, for e.g. transferring selective and targeted information.

Due to a very good mechanical isolation only a very small portion of the vibrations are conducted to the floor and only less sound is released to the neighborhood. This entitles the I-Floor<sup>®</sup> Series for an ideal ad up or even replacement for a conventional sound system in a sound-sensitive environment.

One Exiter in combination with one Low Frequency (LF)-Amplifier allows to connect up to 10 elements of the I-Floor<sup>®</sup> series. For more elements, only another LF-Amplifier has to be added. The LF-Amplifier can drive up to 5 elements at one output channel.

The size of the standardized elements is 1x1m (37,4"x37,4"). The elements could be combined to a quasi single unit due to special connecting lashes system. For special demands in projects, mostly all kinds of shapes could be realized due to CNC production technologies.

**Please consider the following hints to ensure a safe and proper operation of the devices.**

**Inappropriate use may cause damage at the devices, dangers for the user, danger of injury. The warranty may expire due to inappropriate use!**

### **Attention!**

- At the outputs of the low frequency power amplifier dangerous voltages may appear. Take precautions, use isolated cabling, tools and avoid contact to the output cable connections, especially in wet environments.
- Ensure a proper earthing of the device before usage (safety class 1).
- Never connect the outputs to the inputs of the device or inputs and outputs of other devices than stated.
- Use the devices only for the intended purpose.
- Protect the devices from dust, humidity and liquids.
- Pull power plug before opening of the device. Never operate the devices with open covers.
- Opening and servicing of the devices are subjected to qualified personnel only!

## Controls / Connections

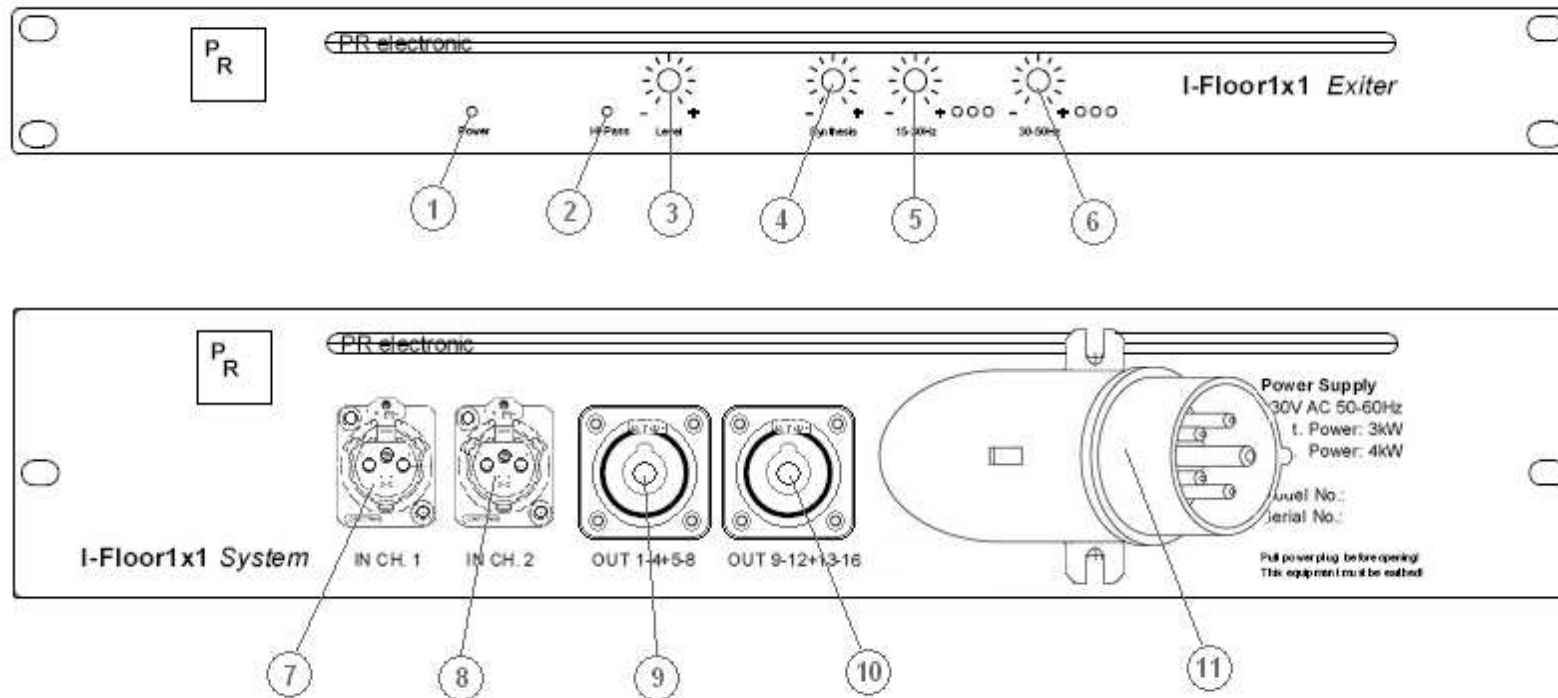

### Controls Exiter:

- |   |   |
|---|---|
| 1. Power indicator                                | Indicates the presence of line power.   |
| 2. Indicator for active frequency separation      | Illuminated if the internal crossover network is active.                      |
| 3. Regulator for main signal output               | Signal attenuation for the output of the exiter to the LF Amplifier.          |
| 4. Regulator for the Infra-Bass signal percentage | Adjusts the percentage of the generated bass signal at the main level (3).    |
| 5. Regulator for the Infra-Bass freq. range       | Regulator for the generated bass signal from the 15-30Hz range of the source. |
| 6. Regulator for the Infra-Bass freq. range       | Regulator for the generated bass signal from the 30-50Hz range of the source. |

## Connections at Back-Panel of the I-Floor® Control:

7. Signal input Ch. 1
8. Signal input Ch. 2
9. Speakon® output for I-Floor elements 1-8
10. Speakon® output for I-Floor elements 9-16
11. Connector for mains supply

Signal input CH 1, XLR balanced (Full-Range, e. g. from audio mixer)  
 Signal input CH 2, XLR balanced (Full-Range, e. g. from audio mixer)  
 Connector for I-Floor® elements (Pins 1± elements 1-4, Pins 2± 2 elements 5-8)  
 Connector for I-Floor® elements (Pins 1± elements 9-12, Pins 2± 2 elements 13-16)  
**Hint:** Output 2 is only connected if 2 LF-Amplifiers are integrated.  
 Power connector for CEE female cable, 230V/50Hz, 1x16 Ampere

## Internal Controls (Back-plane of exiter):

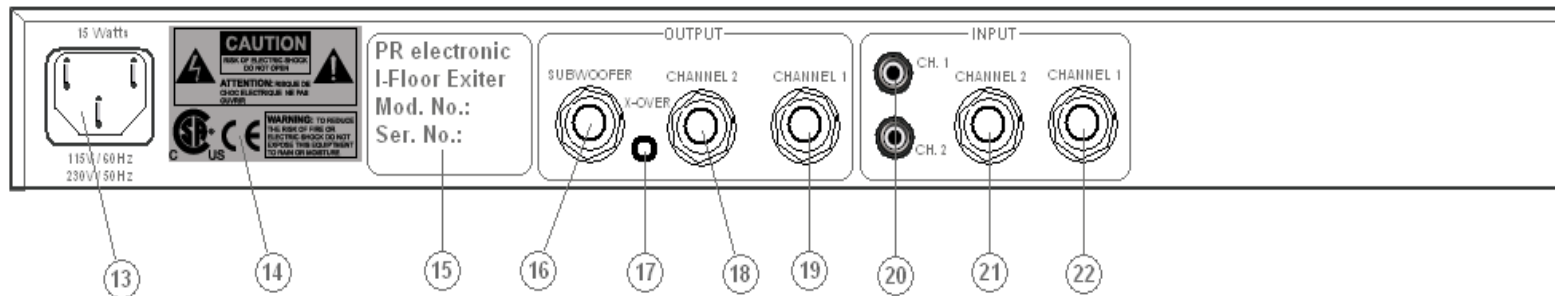

12. IEC input supply  
**Attention!** System voltage has to be adjusted internally by qualified personnel!  
 (System voltage lies close!).
13. CE and engineer standards label
14. Type und serial number label
15. Exit subwoofersignal for I-Floor®
16. Switch für active frequency disconnection
17. Signaloutput audio channel 1
18. Signaloutput audio channel 2
19. Signalinputs audio channel 1+2
20. Signalinput audio channel 1
21. Signalinput audio channel 2

Input supply 115V / 60Hz 230V 50Hz

Information about the for the device used engineer standards.  
 Information about the type of device and serial number .  
 6,3 mm jack plug, symmetric, output to the LF amplifier.  
 Activation of the frequency junction plate between subwoofer and channel 1 + 2.  
 6,3 mm jack plug, symmetric, output 1 to the audiosystem.  
 6,3 mm jack plug, symmetric, output 2 to the audiosystem.  
 RCA (Cinch) plug connector, asymmetric signal from the audiosystem.  
 6,3 mm jack plug, symmetric, input 1 from the audiosystem.  
 6,3 mm jack plug, symmetric, input 2 from the audiosystem.

# Configuration 2 System I-Floor®

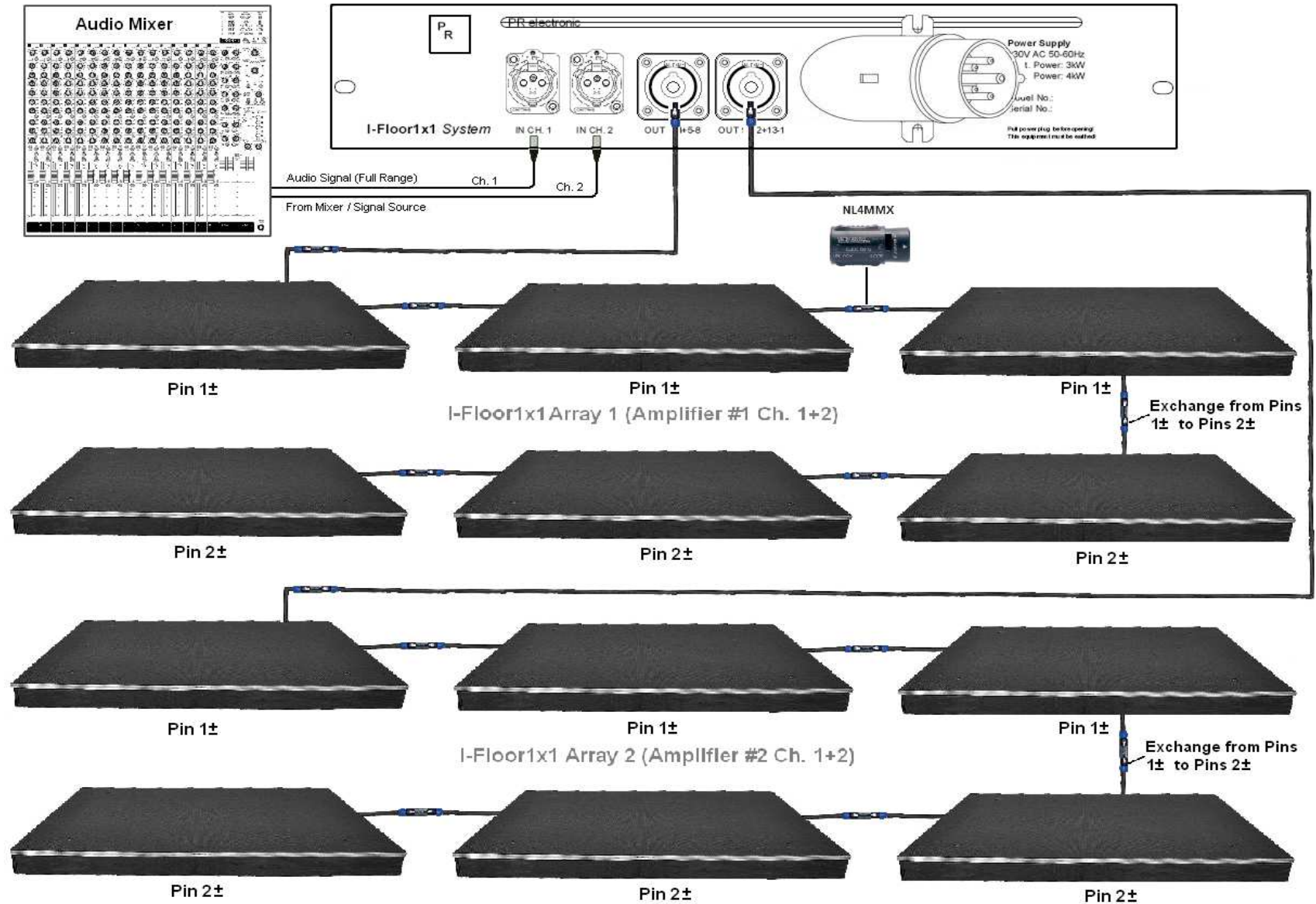

## Installation I-Floor®

### Underground

The I-Floor® elements should be arranged onto a dry and resilient underground. Sidewise there has to be a space of 20 mm minimum, that the system is able to swing freely and no mush occurs. The more massive the underground is built-on the better is the undocking of the vibration from the ground. When the ground is hollowly e.g. elevated grounds, that can cause a transfer of the vibration and mush.

The cables for connecting the several elements are furnished with an absorbtion. If cables or loose foreign materials contact the plates of the I-Floor elements, that can also cause mush. In case of doubt the cables can be isolated from the plates during the installation through very soft foamed material.

### I-Floor® dimensions

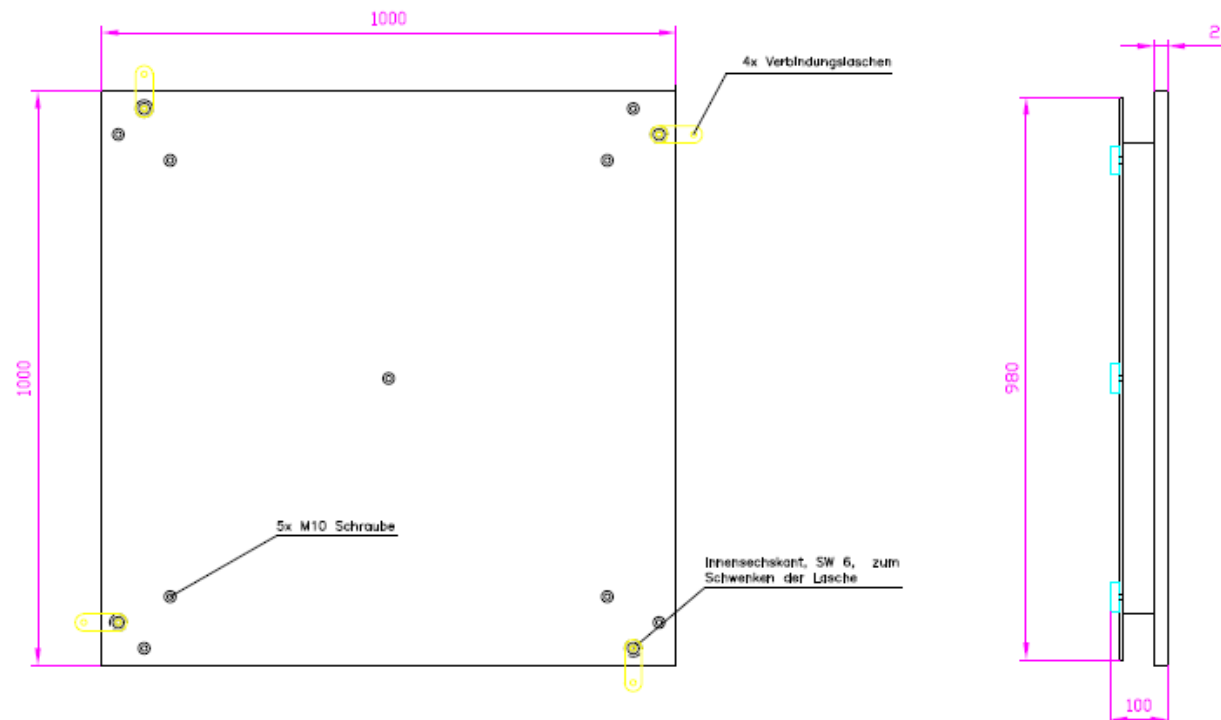

## Mechanical connection of the plates

The several plates have to be connected firmly through the connecting straps, so that a common, swinging surface occurs. The screws [Detail(1)], which serve for tilting out (rotating) the connecting straps are painted black for recognition. Attention! Do not turn the other screws [Detail (4)]. The I-Floor® elements could get damaged thereby.

The connection straps are slewed about 90° [Detail(2)], so that the respectively next element can be screwed through with the provided countersunk screws (M10x40) onto the connection straps Detail(3)]. Therefore the screws should be tightened firmly, but not extremely because otherwise the screw heads could stretch in the timber of the plates.

Advice: The connection screws should be greased at times when the mounting and dismounting is frequently (e.g. rental business), that the winding stays smooth.

## Detail connection straps

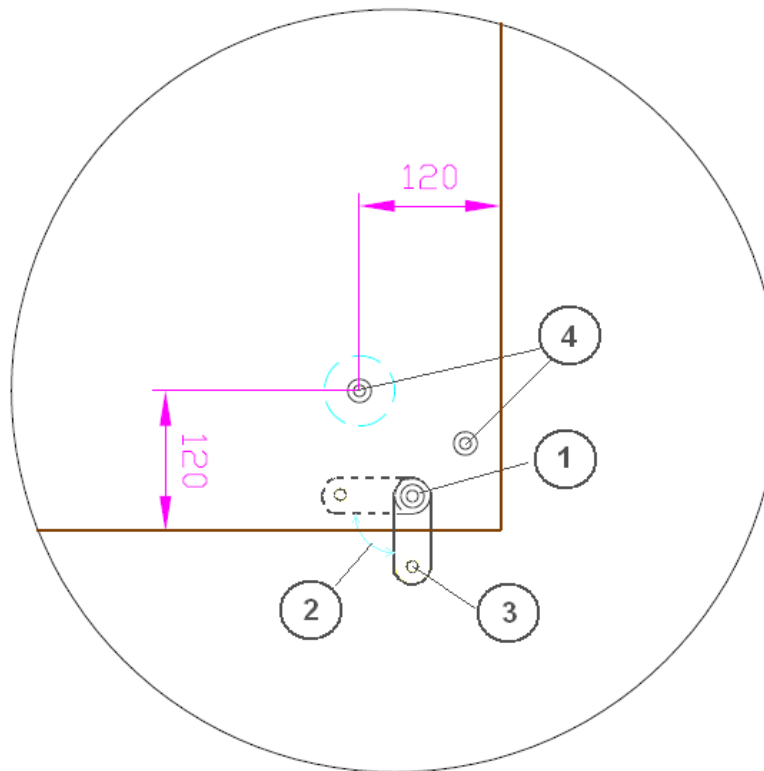



## Adjustment Advices I-Floor® Exiter

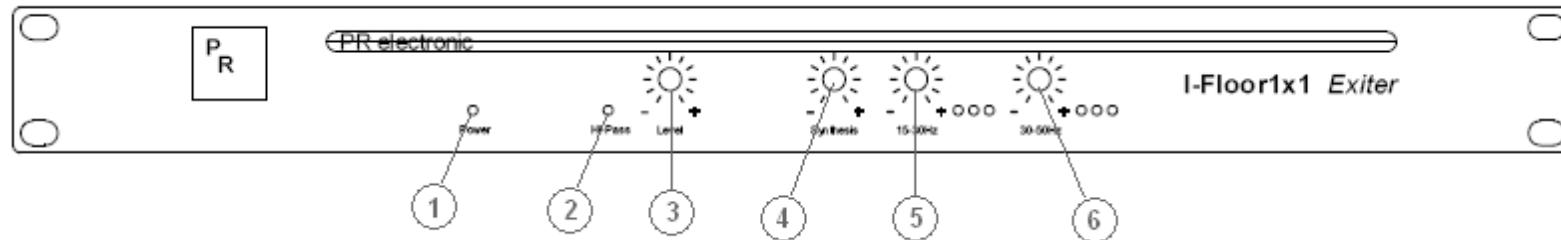

With the **Exiter** of the PR I-Floor® Systems you can adjust the intensity and the way if vibrations of the I-Floor® elements suitable for your needs. The "Level" controller serves for the adjustment of the total signal level, made up of the master signal and the generated bass signals. Adjust at first a relatively low level with the controller "Level" (1) (Recommendation about 1/3 of maximum).

The controller "Synthesis" (2) serves for the adjustment of the amount of the generated bass signal of the total level. Adjust the controller "Synthesis" at first at about 1/3 up to 3/4 of the maximum.

Both of the controllers 15-30Hz and 30-50Hz (5), (6) serve for the choice out of which frequency area of the master signal the generated bass should be produced. Adjust one of these controllers at first at about 1/2 of the maximum.

**Attention!** The level display should only get "red" at the highest signal heights.

After these basic settings turn the controller of the LF-Amplifiers up to maximum.

Then switch the audio signal (of the mixer, cd-player or other devices) on (frequency channel flat, about 0 up to +4 dBU).

Now you can adjust the I-Floor® System optimal suitable for your needs through careful changes of the settings.

Mainly essential is:

For pure vibration effects (e.g. for adventure parks or 4-D cinemas) the amount of the generated basses and the amount 15-30Hz are raised.

At appliances to support or replace the basses of the loudspeakers you mix a little fewer of the generated bass with it and raise the amount 30-50 Hz. The best and cleanest results are achieved when you turn up only one of both areas (15-30 Hz **or** 30-50 Hz).

Attention! If the orange "Clipping" LED of the amplifier lights up the signal of the exiter is setted to high.

# Configuration with Sound Equipment

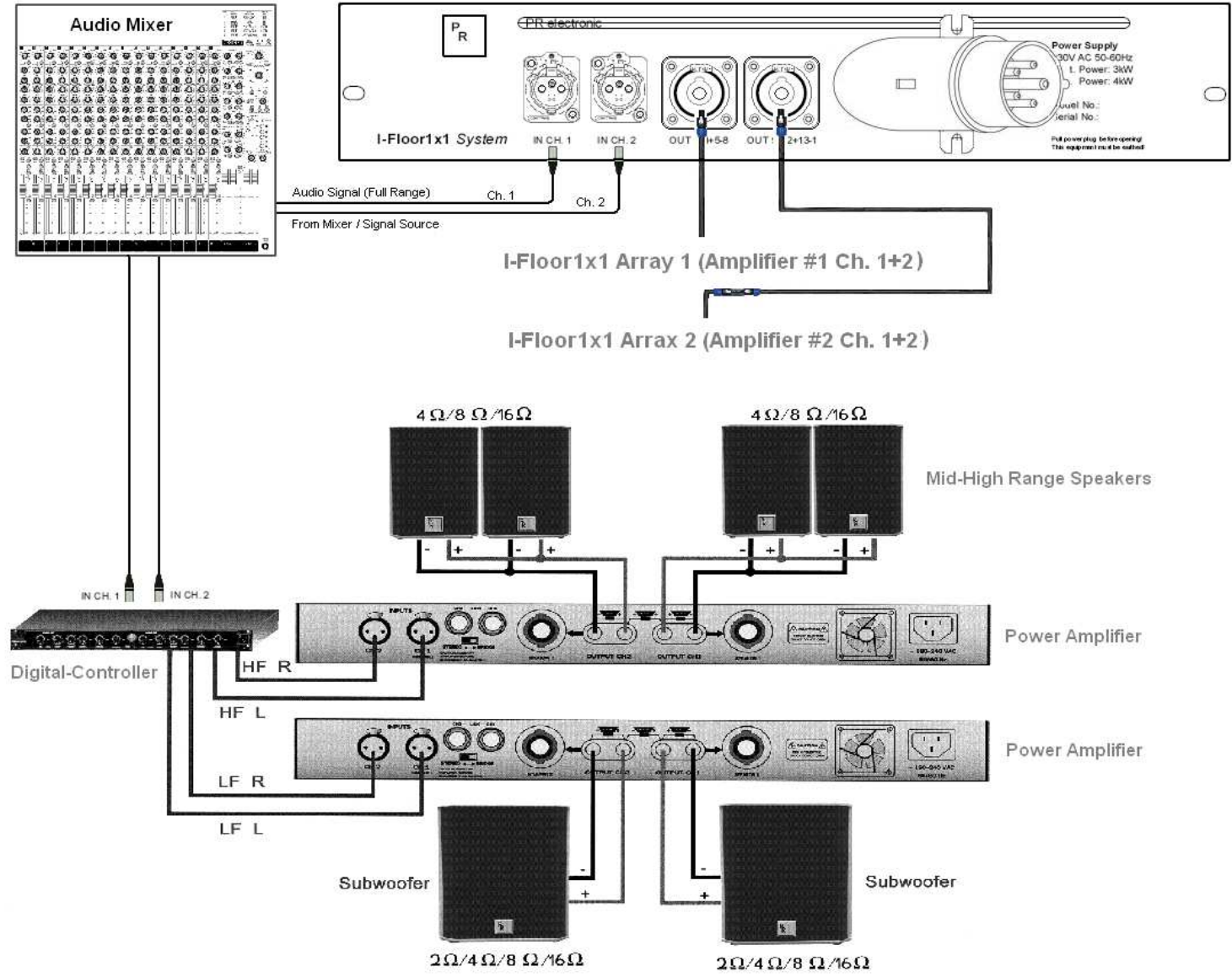

## Access Allocations

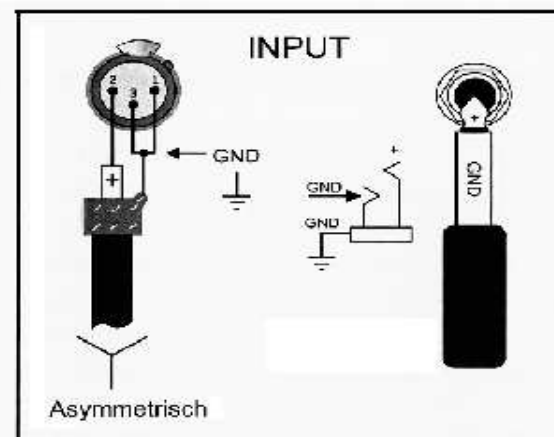
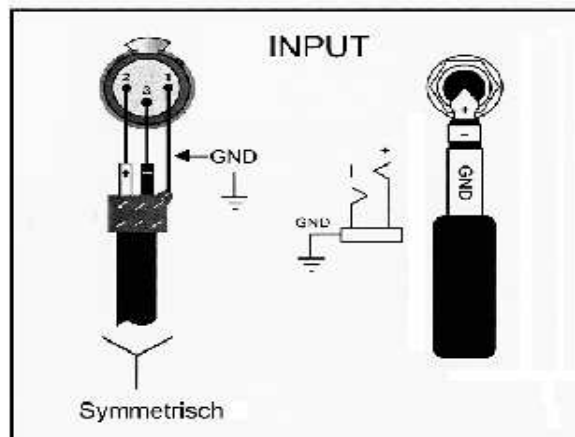
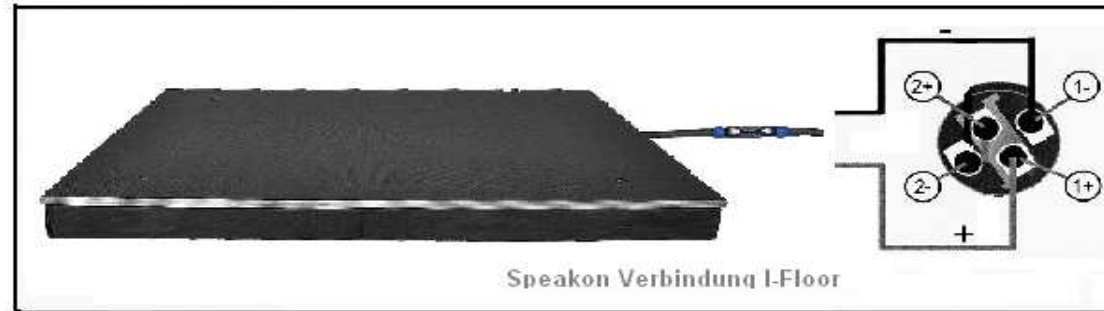

**I-Floor<sup>®</sup> System mit 8 Pieces I-Floor 1x1<sup>®</sup>**

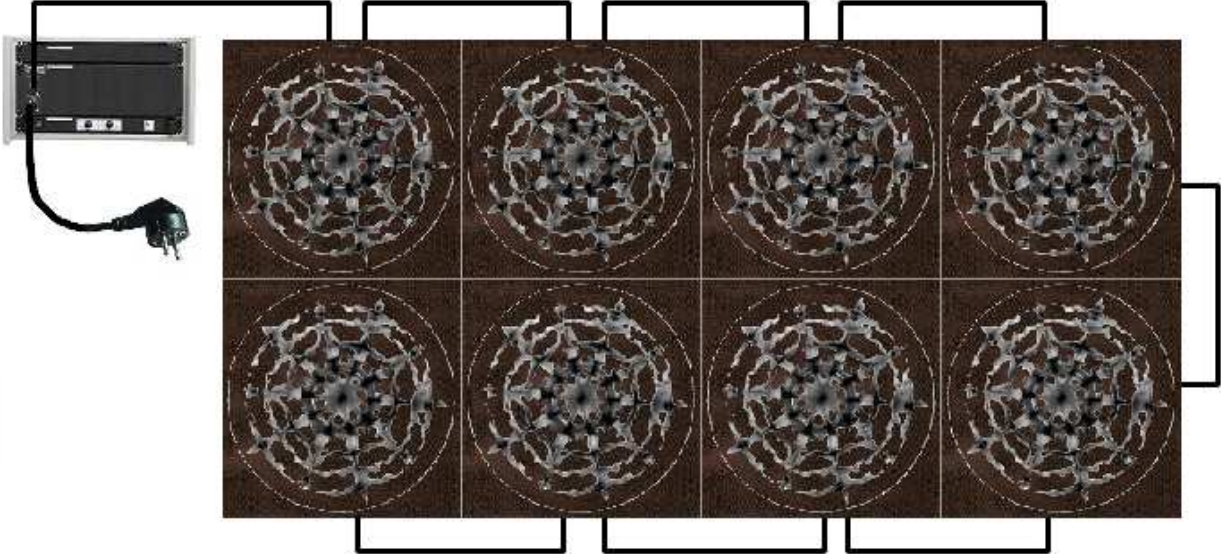

## Technical Data

### Technical Data

**System : I-Floor 1x1, S-Floor 1x1**

Frequency Channel 5Hz - 30Hz (I-Floor 1x1), 15Hz-8kHz (S-Floor1x1)

Amplitude max. 5mm (I-Floor 1x1),

Power/m<sup>2</sup> 400 W (max.)

Nominal Impedance 16 Ohm (8 / 4 Ohm version available)

Input Signal Active Frequency Stimulation in connection with Special-Controller

Basement Multiplex Layer-glued timber

Surface Multiplex phenolic resin, waterproof (all basement coatings possible)

Mounting Integrated Connectionssystem

Circuit Points 2x SPEAKON®

Feet 5 x Gum-foot D=50mm

Dimensions (LxWxH/mm /Inch) 1000 x 1000 x 100mm / 39.37 x 39.37 x 3.94

Net Weight ca. 26 kg / 57,36lbs

**PR Sound** is a brand of **PR electronic e.K.**

Changes of the technical specifications which serve for Improvement are reserved anytime!

State of September 2010

## Service Address

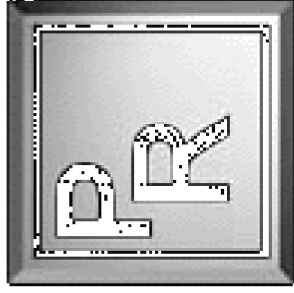

*PR Sound - Respect Your Ears !*

PR electronic e.K.  
Im Steinenbaechle 3  
D-73569 Eschach  
GERMANY

Fon: +49-(0)7175-5600  
Fax: +49-(0)7175-4500  
E-Mail: [service@pr-electronic.com](mailto:service@pr-electronic.com)  
URL: [www.pr-electronic.com](http://www.pr-electronic.com)